



Cu  2616  
'PRESS GAS'

**lok dvojni 90°**

12	
15	
18	
22	
28	
35	
42	
54	

Cu  2616.1  
'PRESS GAS'

**lok enojni 90°**

12	
15	
18	
22	
28	
35	
42	
54	

Cu  2616XL  
'PRESS GAS'

**XL lok dvojni 90°**

64	

Cu  2616.1XL  
'PRESS GAS'

**XL lok enojni 90°**

64	

Cu  2626  
'PRESS GAS'

**lok dvojni 45°**

12	
15	
18	
22	
28	
35	
42	
54	

Cu  2626.1  
'PRESS GAS'

**lok enojni 45°**

12	
15	
18	
22	
28	
35	
42	
54	

Cu  2626XL  
'PRESS GAS'

**XL lok dvojni 45°**

64	

Cu  2626.1XL  
'PRESS GAS'

**XL lok enojni 45°**

64	

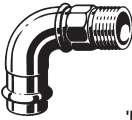
Rg  2614  
'PRESS GAS'

**lok - zunanji navoj**

12- <sup>3</sup> / <sub>8</sub> "	
12- <sup>1</sup> / <sub>2</sub> "	
15- <sup>1</sup> / <sub>2</sub> "	
18- <sup>1</sup> / <sub>2</sub> "	
18- <sup>3</sup> / <sub>4</sub> "	
22- <sup>3</sup> / <sub>4</sub> "	
28-1"	
35-1 <sup>1</sup> / <sub>4</sub> "	
42-1 <sup>1</sup> / <sub>2</sub> "	
54-2"	

Rg  2614.2  
'PRESS GAS'

**koleno - notranji navoj**

12- <sup>3</sup> / <sub>8</sub> "	
12- <sup>1</sup> / <sub>2</sub> "	
15- <sup>1</sup> / <sub>2</sub> "	
15- <sup>3</sup> / <sub>4</sub> "	
18- <sup>1</sup> / <sub>2</sub> "	
18- <sup>3</sup> / <sub>4</sub> "	
22- <sup>1</sup> / <sub>2</sub> "	
22- <sup>3</sup> / <sub>4</sub> "	
22-1"	
28-1"	
35-1 <sup>1</sup> / <sub>4</sub> "	
42-1 <sup>1</sup> / <sub>2</sub> "	
54-2"	

Cu  2615  
'PRESS GAS'

**spojka**

12	
15	
18	
22	
28	
35	
42	
54	

Rg  2615.5  
'PRESS GAS'

**drsna spojka**

15	
18	
22	
28	
35	
42	
54	

Cu  2615XL  
'PRESS GAS'

**XL spojka**

64	

Cu  2615.5XL  
'PRESS GAS'

**XL drsna spojka**

64	

Cu  2618 'PRESS GAS'

**T - kos**

12	
15	
18	
22	
28	
35	
42	
54	

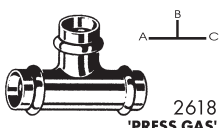
Cu  2618 'PRESS GAS'

**reducirni T - kos**

12-15-12	
15-12-12	
15-12-15	
15-15-12	
18-15-18	
22-12-22	
22-15-15	
22-15-22	
22-18-22	
22-22-15	
28-15-28	
28-18-28	
28-22-28	
35-22-35	
35-28-35	
42-22-42	
42-28-42	
42-35-42	
54-28-54	
54-42-54	

Rg  2611 'PRESS GAS'

**prehodni kos zunanji navoj**

12-3/8"	
12-1/2"	
15-1/2"	
15-3/4"	
18-1/2"	
18-3/4"	
22-1/2"	
22-3/4"	
22-1"	
28-3/4"	
28-1"	
28-1 1/4"	
35-1"	
35-1 1/4"	
35-1 1/2"	
42-1 1/4"	
42-1 1/2"	
54-1 1/2"	
54-2"	

Rg  2612 'PRESS GAS'

**prehodni kos notranji navoj**

12-3/8"	
12-1/2"	
15-1/2"	
15-3/4"	
18-1/2"	
18-3/4"	
22-1/2"	
22-3/4"	
22-1"	
28-1"	
35-1 1/4"	
42-1 1/2"	
54-1 1/2"	
54-2"	

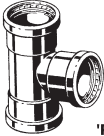
Cu  2618XL 'PRESS GAS'

**XL reducirni T - kos**

64	
64-54-64	

Cu  2615.1 'PRESS GAS'

**reducirka "A"**

15a-12	
18a-15	
22a-15	
22a-18	
28a-15	
28a-18	
28a-22	
35a-22	
35a-28	
42a-22	
42a-28	
42a-35	
54a-35	
54a-42	

Cu  2615.1XL 'PRESS GAS'

**XL reducirka "A"**

64a-42	
64a-54	

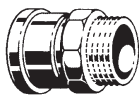
Rg  2611XL 'PRESS GAS'

**XL prehodni kos zunanji navoj**

64-2 1/2"	

Rg  2612XL 'PRESS GAS'

**XL prehodni kos notranji navoj**

64-2 1/2"	

Cu  2656 'PRESS GAS'

**kapa**

12	
15	
18	
22	
28	
35	
42	
54	

Rg  2666 'PRESS GAS'

**privijalo ravno tesnenje**

15-1/2"	
18-1/2"	
22-3/4"	
28-1"	
28-1 1/4"	
28-1 1/2"	
35-1 1/2"	
42-2"	
54-2 1/2"	

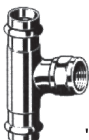
Rg  2617.2  
'PRESS GAS'

**T - kos - notranji navoj**

15-1/2"-15	
18-1/2"-18	
22-1/2"-22	
22-3/4"-22	
28-1/2"-28	
28-3/4"-28	
35-1/2"-35	
35-1"-35	
42-1/2"-42	
42-1"-42	
54-1/2"-54	
54-1"-54	

Rg  2654  
'PRESS GAS'

**privijalo z.n.n. konično tesnenje**

12-1/2"	
15-1/2"	
15-3/4"	
18-1/2"	
18-3/4"	
22-3/4"	
22-1"	
28-3/4"	
28-1"	
35-1 1/4"	
42-1 1/2"	
54-2"	

Fe  2624  
'PRESS GAS'

**montažna plošča**

310 x 60	
----------	--

HNBR  2687  
'PRESS GAS'

**tesnilo GAS**

12	
15	
18	
22	
28	
35	
42	
54	

Rg  2614.6  
'PRESS GAS'

**pritrdilno koleno**

22 x 3/4	
22 x 1	
28 x 1	

Rg  2625.5  
'PRESS GAS'

**kotni prehodni kos**

12-1/2"	
15-1/2"	
18-1/2"	
22-3/4"	

Rg  2652  
'PRESS GAS'

**privijalo n.n.n. konično tesnenje**

15-1/2"	
18-1/2"	
22-3/4"	
28-1"	
35-1 1/4"	
42-1 1/2"	
54-2"	

 G 2110  
'PRESS GAS'

**kroglični ventil**

3/4"	
1"	
3/4" term.	
1" term.	

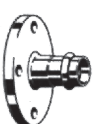
Rg  PN16 2659.5  
'PRESS GAS'

**prirobnica**

(DN 25) 28	
(DN 32) 35	
(DN 40) 42	
(DN 50) 54	
(DN 65) 64	

 2646  
'PRESS GAS'

**PRESS kroglični ventil**

15-1/2"	
18-1/2"	
22-3/4"	

RF  2259.7  
'PRESS GAS'

**prirobnični vijak - set**

DN25/M12x65	
DN32-50/M16x70	
DN65-100/M16x70	

Rg  2650  
'PRESS GAS'

**privijalo dvojno konično tesnenje**

15	
18	
22	
28	
35	
42	
54	