

## Viega Megapress

Presses thick-walled steel:  
cold, safe and in seconds.



**viega**



**Viega.**

# CONNECTED IN QUALITY.

Viega is convinced: Quality is everything. Without quality, everything means nothing. That is why the company strives to exceed itself each and every day. By means of regular dialogue with its customers, by developing better products and service features and by an approach to the future that does not lose sight of its past.

Viega has been connected in quality for over 120 years. It all began with the vision of revolutionising installation technology. With over 4,000 employees and ten locations, we have progressed to become a global market leader in the installation technology sector while still remaining true to our principles and setting our own high standards.

It is of importance to Viega to support its customers in their daily work. To this end, it shares its knowledge with customers all over the world, matches materials, technology and comfort, takes time for quality management and invests in research and development. The result: a perfectly coordinated system providing customers fast and reliable access to over 17,000 products.

**Quality is everything. Without quality, everything means nothing.**

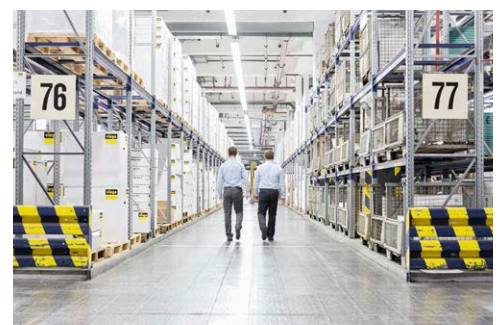

# CONTENTS

6

Viega Megapress: Saves installation time, labour costs and a lot of welding work.

8

Viega Megapress: Quick, clean, safe and completely weld-free.

10

SC-Contur: Ensures leakproof installation of steel pipes. For sure.

12

Industrial and plant room construction: For stringent requirements and highest standards.

14

Domestic technology: A big advantage even on a small scale.

16

Viega Megapress press-in branch connector: Direct connection in just two minutes.

18

Viega Megapress G: Puts an end to welding work in gas installations.

20

Viega Megapress G: Withstands all – even the highest requirements.

22

Pressguns: Permanent connections made in seconds.

24

Pipe overview.

26

The product range.

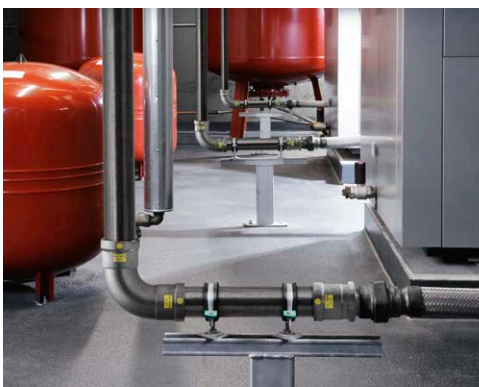





## Viega Megapress

SAVES INSTALLATION TIME,  
LABOUR COSTS AND A LOT OF  
WELDING WORK.

Whether thick- or thin-walled, painted or galvanised, coated or black – steel pipes can be used in a wide range applications, have long service lives and are particularly robust. So it is a good thing that Viega has come up with yet another genuinely innovative technology: Megapress. This system means that steel pipes can now make economic sense in heating, cooling or industrial plant applications.

### One system for all applications

Viega Megapress is the press technology specifically designed for thick-walled steel pipes. The formed-pipe connectors made of 1.0308 steel material with a zinc-nickel coating guarantee the highest quality and durability, and therefore of course a long service life. Steel pipes in compliance with DIN EN 10255 with threaded pipe quality and in compliance with DIN EN 10220/10216-1 and DIN EN 10220/10217-1 in boiler pipe quality, in the sizes 3/8 to 4 inches, can be connected safely and reliably using the Viega Megapress system.

### An economic advantage

Viega Megapress has a clear advantage over common connection methods for thick-walled steel pipes. Especially when it comes to welding, cold press technology is far superior. Although welding is a proven method still today, it always involves high time expenditure, permanent fire risk and strenuous physical effort. This does not only render welding economically unattractive – carrying heavy gas cylinders and welding apparatus is a really back-breaking job, especially if the connection is located several metres high or at hard-to-access locations. Cold press connecting technology makes Viega Megapress simply faster, safer, and more efficient. Viega press tools also make sure that connections are durable and safe.

Applications	Certification
Heating/cooling	TÜV, KITEMARK
Compressed air/technical gases (e.g. nitrogen)	TÜV, KITEMARK
Sprinkler systems/ fire extinguishing systems (wet/dry)	VdS, FM
Shipbuilding	DNV/GL, LR, RINA
Industry	TÜV
District heating (in acc. with AGFW FW 524) with Megapress S up to 2 inches	MPA, FFI



### Through thick and thin

Viega Megapress can be used to connect both thick-walled steel pipes of threaded pipe quality and pipes of boiler pipe quality – even in the intermediate sizes 38,0, 44,5 and 57,0 mm. The connectors are especially designed for processing different external pipe diameters and wall thicknesses, thus offering maximum flexibility.

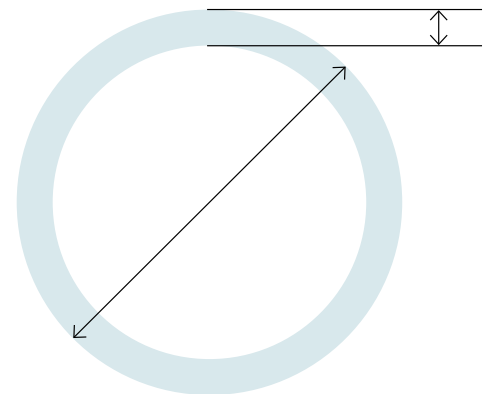

Pipe wall thicknesses and diameters according to DIN EN 10255, DIN EN 10220/10216-1 and DIN EN 10220/10217-1.

Whether seamless, welded, galvanised, industrially painted, epoxy-resin coated or black: Viega Megapress connects pipes with the most different surfaces. Durable and safe – from 3/8 to 4 inches!

- 3/8 inch
- 1/2 inch
- 3/4 inch
- 1 inch
- 1 1/4 inch
- 1 1/2 inch
- 2 inch
- 2 1/2 inch
- 3 inch
- 4 inch

○ Megapress S (FKM sealing element)

● Megapress (EPDM sealing element)

● Megapress G (HNBR sealing element)

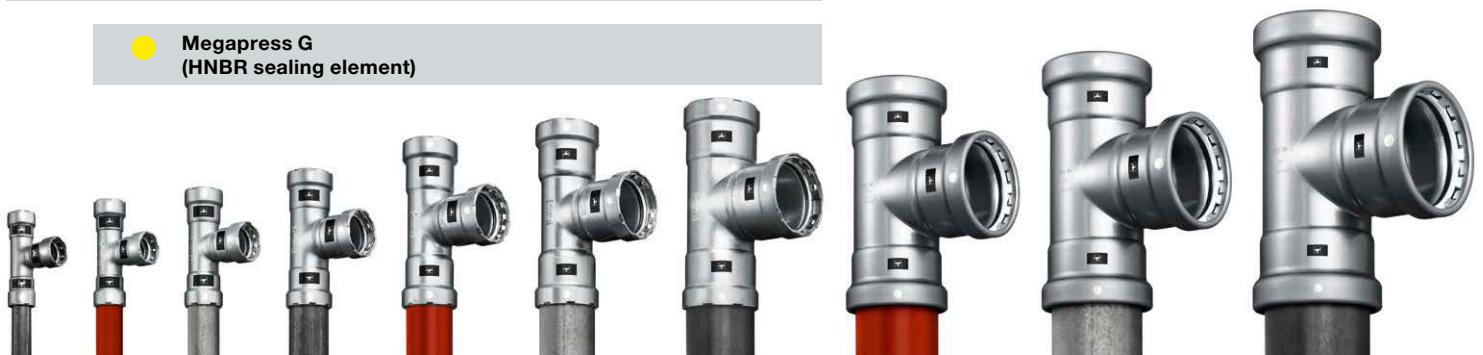

## Viega Megapress

# QUICK, CLEAN, SAFE AND COMPLETELY WELD-FREE.

Black steel pipes formerly meant: welding work. With Viega Megapress, press technology now finds its way into steel pipe installation and delivers a whole range of advantages.





### Up to 60% faster completion

The connection with Viega Megapress is ready in a few working steps. Just cut the steel pipe to length, deburr and clean it, and transfer the insertion depth of the connector to the pipe end (Fig. 1). Then put the connector on the pipe and apply the press jaw or press ring (Fig. 2). Join Megapress connectors from  $\frac{3}{8}$  to 2 inches with the aid of a Viega press machine (Fig. 3), and in addition establish a force-fit connection for pipes from  $2\frac{1}{2}$  to 4 inches using the Pressgun Press Booster (Fig. 4). Finally remove the safety tag on the press connector to indicate that pressing had already been completed at this place. It is irrelevant which steel pipe wall thickness is used as long as the pipes are compliant with DIN EN 10255, DIN EN 10220/10216-1 or DIN EN 10220/10217-1.

The result is a safe and guaranteed leakproof connection which is ready for use. Cooling times or a fire guard are no longer necessary. And the best of all: Press technology is not only safer and easier but also more efficient. Viega Megapress can save up to 60% installation time compared with welding for the sizes from  $\frac{3}{8}$  to 2 inches for the connection technology. It is even up to 80% for sizes from  $2\frac{1}{2}$  to 4 inches. Megapress XL can be used for example to complete a press connection of 4 inches in less than 20 seconds. As the circumstances

may be, welding takes more than 25 minutes. It's similar with other methods such as threaded, roller groove, or coupling connections. They can also in terms of speed not keep up with cold press technology and consume significantly more time.

### A new dimension of force

With the XL dimensions, larger steel pipes from  $2\frac{1}{2}$  to 4 inches can be pressed as well. It's logical that the force needed for a force-fit connection increases – but equally logical and clever is the Viega solution: the Pressgun Press Booster. This force booster which is attached to a Viega press machine ensures the required press energy for a reliable connection. The geometry of the spherical heads of the hinged adapter jaw had been especially developed for pressing with the Megapress XL press rings. This geometry reliably transfers the higher pressing force and rules out accidental use with incompatible press rings. The carrying strap additionally attached to the press tool as well as the low weight of the Pressgun Press Booster ensure the best possible ergonomics while working. This makes the Pressgun Press Booster one of the most innovative solutions on the market.

In addition you find the installation steps on: [viega.com/Video-megapress](http://viega.com/Video-megapress)

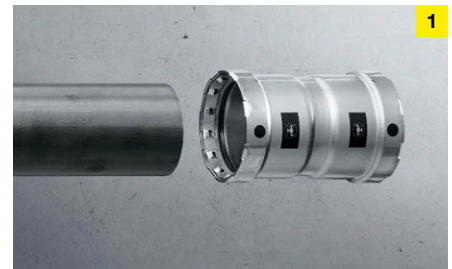

The steel pipe is cut to length and cleaned. Then the insertion depth is measured and marked, then the Megapress connector is put on the pipe up to the mark.



For pressing Megapress connectors from  $1\frac{1}{4}$  inch upwards, only press rings with hinged adapter jaws are used. For smaller sizes between  $\frac{3}{8}$  and 1 inch, both press jaws and press rings with hinged adapter jaws are available.



The connector is pressed in a few seconds using a Viega press machine thus connecting it with the pipe by a force-fit connection.

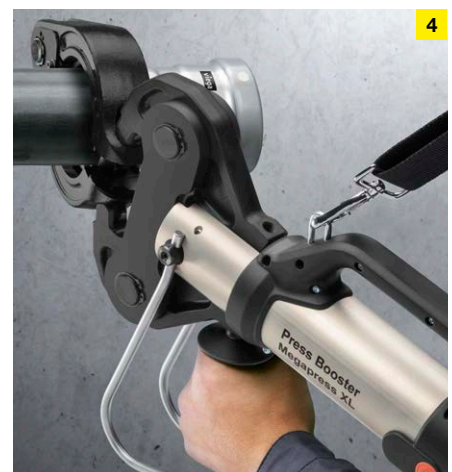

Megapress XL connectors are pressed easily, quickly and safely using a press machine and the Pressgun Press Booster.



### REASONS FOR VIEGA MEGAPRESS

- In terms of economy, up to 60% less installation time for connection compared with welding for sizes from  $\frac{3}{8}$  to 2 inches, and up to 80% for sizes from  $2\frac{1}{2}$  to 4 inches.
- Absolutely fire-safe, because neither flames nor fumes arise with cold press technology.
- No additional time and cost expenditure for fire protection precautions.
- Viega SC-Contur in all Megapress connectors. This immediately indicates any inadvertently unpressed connections during the pressure test.
- For universal use. Presses thick-walled steel pipes with nominal connection diameters from  $\frac{3}{8}$  to 4 inches, regardless whether the pipe is seamless, welded, black, galvanized or epoxy resin coated.
- Thanks to the innovative Pressgun Press Booster, steel pipes of sizes  $2\frac{1}{2}$ , 3, and 4 inches can also be force-fit connected.



## Viega Megapress with SC-Contur

# ENSURES LEAKPROOF INSTALLATION OF STEEL PIPES. FOR SURE.

The unsurpassed economic advantage of press technology is obvious right from the very first connection. And when it comes to safety: Megapress – as with all Viega press systems – also stands out thanks to the SC-Contur.

Viega SC-Contur is an innovative safety feature that causes guaranteed forced leakage in unpressed connections. This identifies any inadvertently unpressed connections during the leakage test and they can be pressed subsequently. Viega SC-Contur ensures 100% safety – over the entire testing range.

### **Complex requirements, simple solution**

Of course, Viega Megapress and Megapress S are equipped with SC-Contur. With the Megapress systems, the forced leakage is achieved by means of tolerance optimization between the

press connector and the steel pipe. Forced leakage is produced in Megapress by an optimised tolerance between the press connector and the steel pipe. This is the best answer to the special requirements on a connector made by the different wall thicknesses and surfaces of steel pipes. Megapress becomes a flexible steel pipe connector system by matching the connector diameter to the large number of steel pipe variants (Fig. 1).

### **Safety at a glance**

SC-Contur allows the leak tightness of the entire installation to be checked

simply but effectively. The dry testing range is between 22 mbar and 3 bar, while the testing range for wet leakage testing is from 1.0 to 6.5 bar. Viega Megapress thus does not only satisfy the requirements of common standards and regulations, but even surpasses them in some cases – for example with a significantly larger pressure range.

**Not for drinking water**

Viega Megapress is not suitable for installation in potable water pipelines, except for the Megapress silicon bronze adapter fitting for galvanised steel pipe-work. Every single connector has a clearly visible mark (Fig. 2). This rules out mixing up or accidental incorrect use of Viega Megapress.

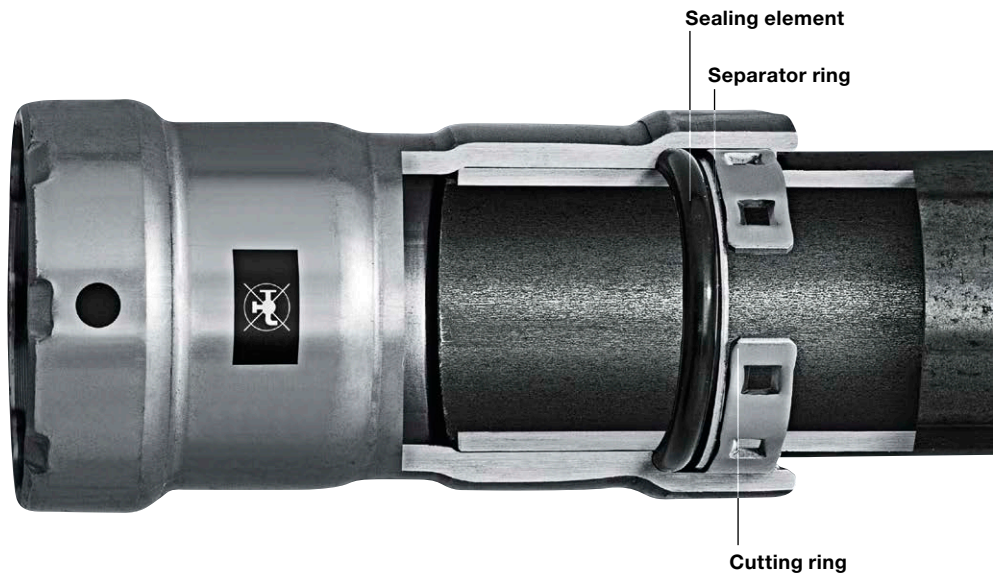

To prevent damage to the sealing element when the pipe is inserted, Megapress fittings up to 2 inches feature a protective separator ring. The cutting ring bites into the pipe during pressing and gives particular strength to the connection.

**Safe for all applications**

Megapress connectors of sizes from 3/8 to 2 inches have a profile sealing element made of EPDM (Fig. 3) and can be used for operating temperatures up to 110 °C. The Megapress S connectors are provided with FKM sealing elements and are suitable for operating temperatures up to 140 °C. The Megapress S connectors in the sizes from 3/8 to 2 inches have a round sealing element (Fig. 4) as well as a strengthened separator ring. The Megapress S XL connector in the sizes 2 1/2, 3 and 4 inches, on the other hands, are provided with round sealing elements with a larger cord size (Fig. 5).

With all Megapress sealing elements it is possible to press seamless, welded, galvanised, industrially painted, epoxy resin coated and black steel pipes using the same type of connector. In pressing, the Megapress profile sealing element encloses the pipe at three points simultaneously, ensuring that the connection is absolutely leakproof even where the surfaces are rough. The design of the Megapress S connectors provides for the same sealing characteristics, so no profile is needed.

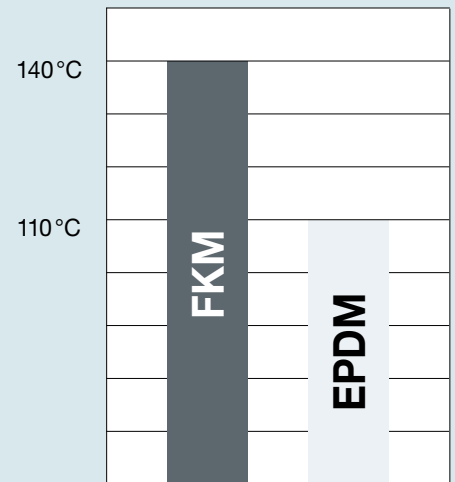

Maximum operating temperatures of the various sealing elements



Megapress profile sealing element up to 2 inches



Megapress S sealing element up to 2 inches



Megapress XL sealing element over 2 1/2 inches

# Viega Megapress/Megapress S – for industrial and plant room construction FOR STRINGENT REQUIREMENTS AND HIGHEST STANDARDS.

Lots of things have to be observed for pipeline installation in industrial applications. Whether cooling systems, heating systems, sprinkler systems, compressed air systems or district heating plants – each application has unique requirements that may well make larger sizes necessary. In all such cases, Viega Megapress/Megapress S provide a variety of benefits that make the decisive difference.



## Large pipe sizes for low temperatures

When it comes to cooling systems, it is generally known that larger dimensions are used to transport the required cooling capacity (Fig. 1). The XL sizes from 2½ to 4 inches satisfy this requirement while making it possible to dispense with welding completely even for large cooling systems. The system can even be downsized without any problems using Megapress sizes from ¾ to 2 inches.

## Corrosion protection and time savings with one connector

Corrosion protection must be given special attention in cooling systems. The high temperature gradient between the medium conveyed and the surrounding room air quickly results in the formation of condensation water thus increasing the risk of corrosion. To avoid this, in most cases industrially painted steel pipes with a coating according to AGI-Arbeitsblatt Q 151 (AGI Worksheet Q 151) are used in cooling systems. However, if the installation is joined by welding, it is required to remove just this coating from

the pipe at first and then extensively re-apply it after welding. This is different when using Megapress. The connectors can be pressed immediately on the coated pipe according to AGI Worksheet Q 151.

## Industrial heating systems

Thick-wall steel pipes are perfect for being used in industrial applications. The Megapress system can withstand the high industrial requirements and is installed quickly and safely thanks to the cold press technology.

### Local and district heating plants

With the new Megapress S sizes of  $\frac{3}{4}$  to 2 inches, it is now possible to press thick-walled steel pipes in local and district heating plants as well. The press connectors can be used from the point of entry to the building for primary and secondary circuits with indirect connection as well as for systems with direct connection. The FKM round sealing element is suitable for operating temperatures up to 140 °C. The new Megapress S sizes (up to 2 inches) fulfil the stringent requirements of the AGFW specification sheet FW 524. Many examinations by independent laboratories as well as an inspection report from the Materialprüfungsamt Dortmund (MPA, Material Testing Agency) confirm the suitability for district heating plants in accordance with AGFW FW 524. Special components such as the flat sealing plug-in piece and PN 25/40 flange round off the Megapress S range of articles that have been designed for practical use.



2



3

### Sprinkler and fire extinguishing systems

Sprinkler systems of thick-walled steel pipe (Fig. 3) are mandatory due to their reliability, durability, stability and long service life in buildings of high risk classes, e.g. industrial and commercial facilities. After all, they must not only resist the intense heat in the event of a fire but also withstand the stringent external operational demands in everyday use. Viega Megapress with the sizes from  $\frac{3}{4}$  to 4 inches is ideal for construction and extension of such sprinkler systems. The system complies with the specifications of the highest risk classes

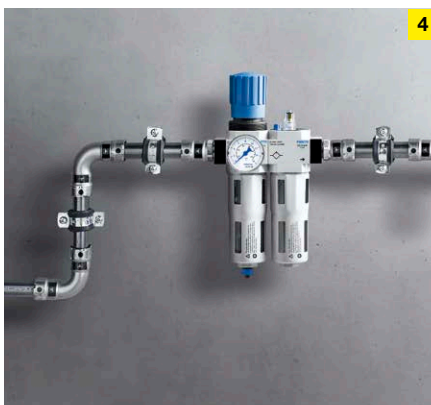

4

and has VdS certification. Until now it was permitted to use only grooved coupling systems or welded systems in the highest fire hazard classes (production and storage risks). With Megapress, press technology can now be used without any concerns.



5

### Compressed air systems and technical gases

Good examples for steel pipe installations in industrial applications are compressed air systems (Fig. 4) and pipe networks for technical gases such as for example nitrogen (Fig. 5).

Viega Megapress also in these cases satisfies the high requirements, facilitates installation in the ceiling area of industrial buildings, and enables convenient T-piece installation for extra fast, safe, and clean connection with devices.



## Viega Megapress in domestic technology

# A BIG ADVANTAGE EVEN ON A SMALL SCALE.

Thick-walled steel pipes have always played a decisive role in heating installations due to their ruggedness. They can be frequently found in new installation systems but also in older systems and thus in refurbishments. It is an advantage having such a wide-range system as Viega Megapress available.

### Simple connection of old and new

It is common to find steel pipe installations during the refurbishment of older residential buildings. Due to their ruggedness, there can often be decades-old pipelines that are in a good condition. Often the installer has to establish a connection with the existing installation, e.g. when replacing the boiler. Until now it was only possible to connect a new boiler with an existing steel pipe system by the time-consuming installation of a threaded adapter or welding. Especially in this case it happens that water running with a delay extends the installation period. In addition, there is an increased risk of fire caused by highly

combustible materials used within the old building's construction. Megapress makes welding unnecessary and consequently rules out any fire risk. Press technology ensures a safe and fast work sequence as well as economic connection to the existing thick-walled steel pipes.

### Fast crossover from the boiler pipe to the threaded pipe

Megapress does not only make the general connection to existing steel pipes an easy task. Easily connecting pipes with different sizes is also possible. The Megapress adapters and reducing sleeves now allow unproblematic con-

nection of steel pipes with the special external diameters of 38,0, 44,5 and 57,0 mm (Fig. 1).

### No costs for additional tools

The connectors are – in spite of the special boiler pipe dimensions – installed with the existing Megapress press rings. For trade professionals, this means: no costs for additional tools!



#### Great benefits even from 3/8 inch

With the size 3/8 inch Viega offers all that is necessary for the laborious task of replacing radiators in steel pipe installations – and thus it is a genuine problem solver, for example for the refurbishment of old buildings. Megapress not only eliminates any fire risk (thereby protecting the existing building), but also prevents floor and wall coverings becoming damaged or soiled. This is because

when working with the welding torch or the thread cutter, the difficult space conditions make it almost impossible not leaving any traces behind. Megapress can now be used to connect new radiators to existing steel pipes fast, easy and simple (Fig. 2).



#### Just squeeze repairs in

It's similar when it comes to a repair or subsequent installation of T-pieces for a radiator connection. With welding this is a time consuming challenge, but one that can be easily overcome with the Viega Megapress sliding repair sleeve (Fig. 3). The piece concerned is cut out, the sliding repair sleeve installed in between and then pressed-in safely. Repair or extension is ready.

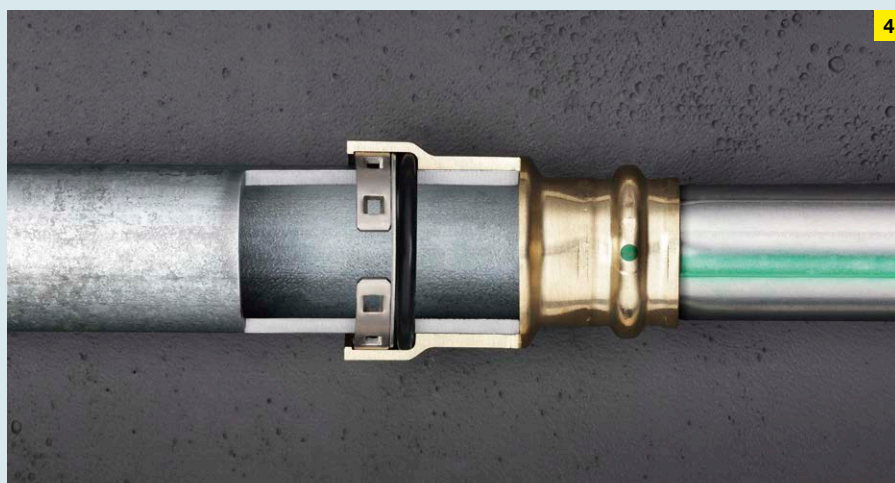

#### Special adapter for drinking water pipelines

The Viega Megapress system is not suitable for being used in drinking water systems. Nevertheless, galvanised steel pipelines can still be found in existing drinking water installations. The Megapress adapter of silicon bronze (Fig. 4) allows for continued use of copper and stainless steel pipes without restrictions, making refurbishment of existing buildings an easy task. The adapter is available in the sizes 1/2 inch x 15 mm to 2 inches x 54 mm.

## Viega Megapress/Megapress S press-in branch connector

# DIRECT CONNECTION IN JUST TWO MINUTES.

Steel pipes are the synonym for long service lives and ruggedness. What happens however if an additional connection is intended to be installed in an existing installation system? What was previously only possible with a great deal of effort can now be done quickly, efficiently and conveniently using Viega's press-in branch connectors.





### Flexible deployment

The Megapress press-in branch connectors with EPDM or FKM sealing elements are real problem-solvers when it comes to retrofitting connections to an existing steel pipe installation. The suitable complete tool set allows drilling holes in thick-walled steel pipes without elaborate preparatory work and press-in the new connection.

A commercially available drill and a Viega press machine (except for Picco) are perfect for using it. The press-in branch connectors are suitable for steel pipes as per DIN EN 10255, DIN EN 10220/10216-1 or DIN EN 10220/10217-1 in the sizes 1½, 2, 2½, 3, 4, 5 and 6 inches and available with a ¼ inch internal thread. A reducer to ½ inch internal thread is also available.

### Up to 80% faster

The press-in branch connector can save up to 80% on installation time compared to welding in new connections. The physical strain for the installer is reduced, and thanks to the factory-fitted profiled sealing elements (EPDM or FKM) the connection between the pipe and the connector is permanently sealed after only two minutes.



1. Attach a special drill guide on the steel pipe to guide the drilling shaft.



2. Drill the hole with the drilling machine and remove drill guide.

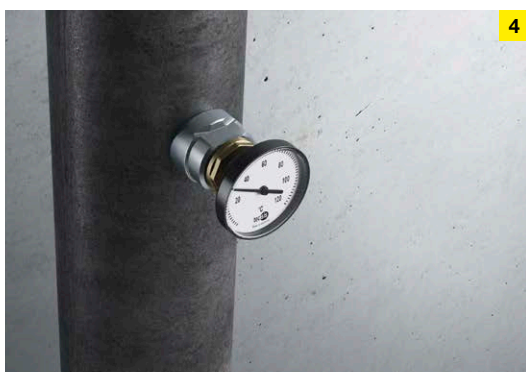

4. A perfect steel pipe connection, e.g. for a thermometer, a manometer or drainage.

### A clean affair

Installing a new connection in the steel pipe is not only easy but also clean. A workshop vacuum cleaner can be attached to the drill guide and swarf produced by drilling can be extracted directly.

### Saves costs and space

The press-in branch connector is a cost and space-saving solution for subsequent installation of a new connection. The pipe is spot-drilled only and not entirely disconnected as e.g. when installing a T-piece. This allows using the press-in branch connector even at locations which are difficult to access.

### Fast and safe before, during, and after installation

The press-in branch connector is fast and efficient not only while installing it but also before and after. The positioning aid significantly simplifies proper alignment of the press-in branch connector on the pipe. This ensures a higher level of safety. Thanks to cold press technology even water flowing out with a delay for example in the piping system is no problem for installing the connection.

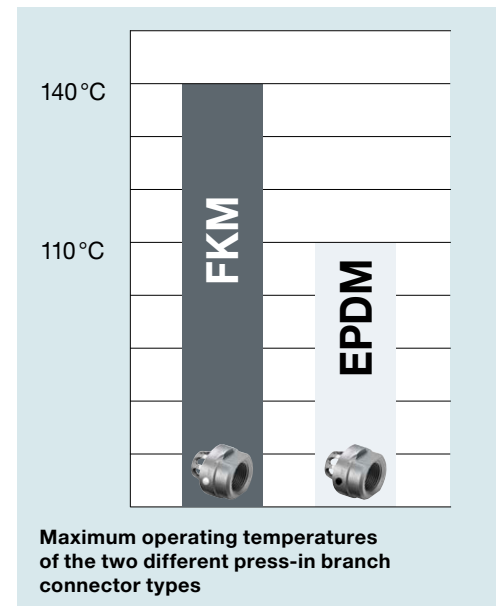

Maximum operating temperatures of the two different press-in branch connector types

Waiting times and downtimes of the system are reduced to the minimum.

In addition you find the installation steps on: [viega.com/Video-megapress](http://viega.com/Video-megapress)

**The Megapress press-in branch connectors are not suitable for gas installations.**



The tool set for the press-in branch connector includes all parts necessary for subsequent installation of connections in existing pipelines: drill guide, drilling shaft, press machine insert and positioning aid.

## Viega Megapress G

# PUTS AN END TO WELDING WORK IN GAS INSTALLATIONS.

Safety comes first when gas is concerned. Therefore thick-walled steel pipes are ideally suited for industrial gas installations – and can now be cold-pressed using Viega Megapress G to deliver a safe, reliable and economic connection.



**Tried-and-tested quality**

Cold press technology now finds its way into gas installations by Viega Megapress G. The connector is almost identical with Viega Megapress: a base unit of formed-pipe steel material 1.0308 with a zinc-nickel coating. A combination that has been tried and tested already in many gas installations in Europe and the USA.

Applications	Certification
Natural and liquid gases according to DVGW Worksheet G 260	DVGW
Fuel oil and diesel fuels	DIBt
Shipbuilding	DNV/GL, LR, RINA
Industry	TÜV, KITEMARK



**Tried-and-tested safety**

No doubt about it – Megapress G also offer the largest possible safety in installation because it also comes with the proven Viega SC-Contur. Any inadvertently unpriessed connectors can be immediately detected during the dry leakage test. The Megapress G press connectors fulfil their function not only at a pressure point but over the entire testing range between 22 mbar and 3 bar. That even exceeds the requirements of standards and regulations.

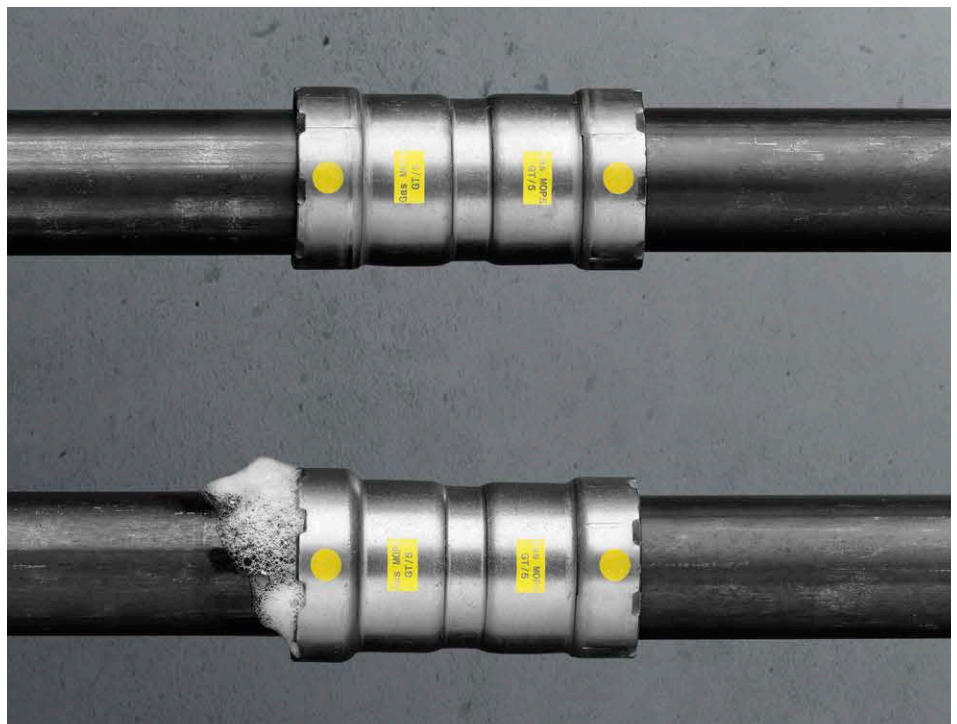

**Profile sealing element made of HNBR**

The technical specifications of the material are tuned to being used in gas installations as well as fuel oil and diesel fuel systems. The Megapress G sealing element also encloses the pipe on three points at the same time thus ensuring that the connection is absolutely leak-proof even with rough pipe surfaces.

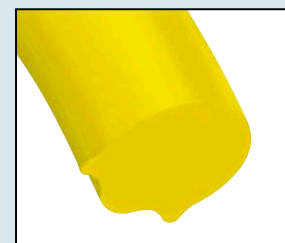
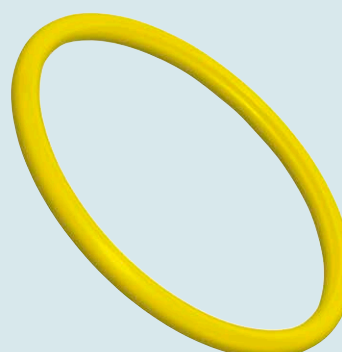

## Viega Megapress G can be used in a multitude of applications WITHSTANDS ALL – EVEN THE HIGHEST REQUIREMENTS.

Viega Megapress G covers a broad installation spectrum with a large number of new components such as elbows, sleeves, T-pieces, flanges, threaded adapters and screwed connections in sizes from ½ to 2 inches. The system is approved both for natural and liquid gases according to DVGW Worksheet G 260 and for installation systems according to DVGW-TRGI 2018 and TRF 2012. The system is also suitable for media such as fuel oil, diesel, compressed air, as well as for use in industrial systems. In addition, Viega Megapress G is HTR-tested and approved for use to the maximum operating pressure of 5 bar (MOP 5). Ideal preconditions for reliable gas installations.



### Up to 60% faster

The great advantage of Megapress G: It is no longer necessary to weld thick-walled steel pipes from ½ to 2 inches and all the negative side-effects of welding are done with. This makes Megapress G above all interesting for buildings with high fire loads and fire protection requirements. Work is also made much easier as already available press tools can simply be used to establish a permanently tight pipe connection within a few seconds. To summarise, installing Megapress G is, with regard to the connection method, up to 60% faster than welding – and up to 100% safer.



### More than just gas

Industrial gas installations are one of the central areas of application for Megapress G. Nevertheless, the system can do even more. Megapress G can also be used for installation of fuel oil

and diesel fuel systems as well as compressed air systems with oil-containing media over 25 mg/m<sup>3</sup>. Regardless whether pipes of threaded or boiler pipe quality are used for installation or whether the pipe is seamless, welded, galvanised,

industrially painted, epoxy-resin coated or black. Megapress G can be used for pressing all pipes according to DIN EN 10255, DIN EN 10220/10216-1 or DIN EN 10220/10217-1 (for details, refer to p. 24).

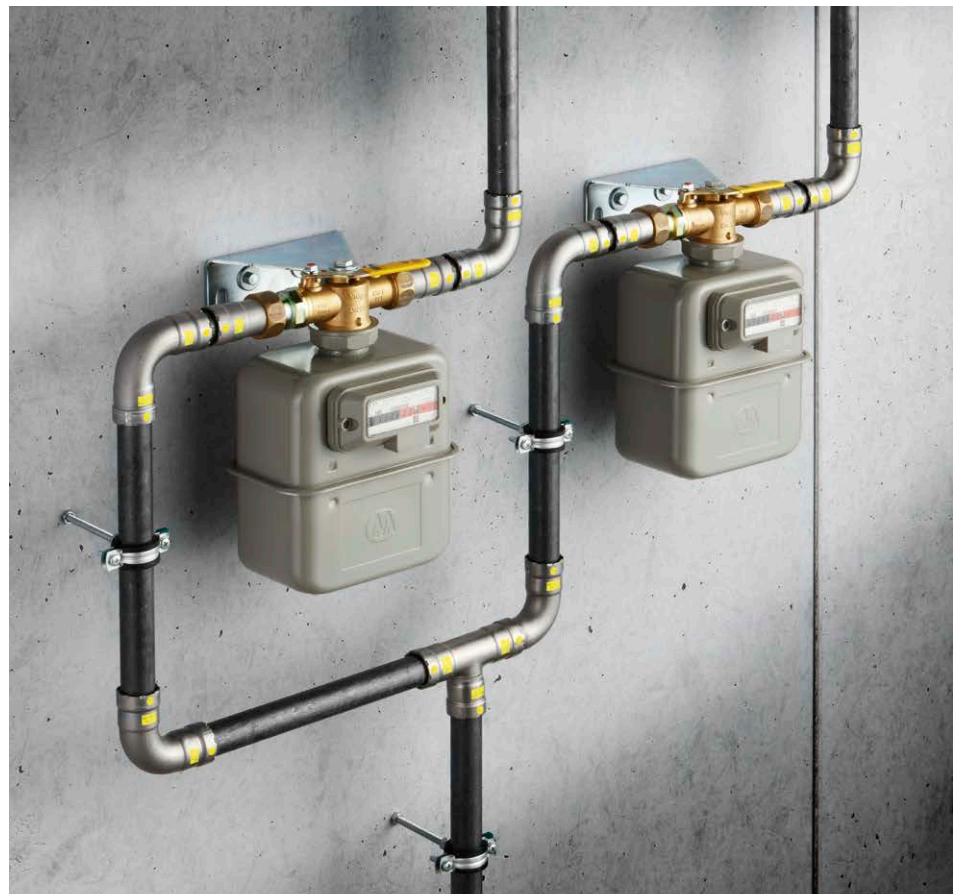

### REASONS FOR VIEGA MEGAPRESS G

- Suitable for natural and liquid gases according to DVGW Worksheet G 260 and for fuel oil and diesel fuel systems.
- Economical thanks to up to 60% less installation time when compared with welding with regard to the connection method.
- Absolutely fire-safe, because neither flames nor fumes arise with cold press technology.
- No additional time and cost expenditure for fire protection precautions.
- Safety thanks to the Viega SC-Contur.
- Presses thick-walled steel pipes with nominal connection diameters from ½ to 2 inches, irrespective of whether the pipe is seamless, welded, black, galvanised or epoxy resin coated.



## Viega Pressguns

# PERMANENT CONNECTIONS MADE IN SECONDS.

Both Viega Pressgun 5 and Viega Pressgun Picco excel with maximum quality enabling an easy and safe installation, even under the toughest of conditions. The new Pressgun Press Booster provides Pressgun 5 with still more power to enable pressing of large dimensions. The press tools with the associated TÜV certifications and extra long service intervals are particularly reliable and economical – thus counting among the finest available to the trade.

### Commonalities

- Easy to handle, ergonomic Pressgun design.
- Lightweight 18 V/2.0 Ah lithium ion high-performance batteries with deep discharge protection and improved cold-start function; optionally available for higher capacity requirements: 18 V/4.0 Ah batteries.
- Cordless battery operation or optional mains power lead.
- Utmost flexibility in each space situation thanks to the press head rotatable by 180° and the press rings with articulation.
- Integrated LED lamp for clear illumination of the pressing point.
- Safety standards checked by recognised authority (TÜV): tripping delay, pin retainer, maintenance display and automatic safety lock.

### Special features of Pressgun Press Booster

- Innovative force amplifier for Megapress XL with integrated hinged adapter jaw for sizes 2½, 3 and 4 inches.
- Optimised press force for maximum safety.
- Weight only 9 kg and a handy carrying strap make for good ergonomics and easy handling.
- Can be used with all Viega press machines from type 2 to Pressgun 5 (not compatible with Pressgun Picco or PT3-AH).
- Special spherical heads on the hinged adapter jaw ensure that there can be no confusion with other Viega press rings.
- Long service interval thanks to Viega's typical reliability.



**Pressgun 5 press technology accessories in the handy set case, consisting of three press jaws (1/2 to 1 inch), three press rings (1 1/4 to 2 inches) and a hinged adapter jaw Z2.**



**Pressgun Press Booster and 2 1/2 inch press ring in a handy case and a case with two press rings (3 and 4 inches).**

#### Special features of Viega Pressgun 5

- For metal piping systems of sizes 12 to 108 mm, for Megapress steel pipe connectors of 3/8 to 4 inches, for plastic piping systems from 12 to 63 mm.
- Only 3.2 kg weight (without press jaw).
- Long maintenance intervals: after 40,000 pressings or 4 years.
- Automatic safety lock after 42,000 pressings.

#### Special features of Viega Pressgun Picco

- For metal piping systems of sizes 12 to 35 mm, for Megapress steel pipe connectors of 3/8, 1/2 and 3/4 inches, for plastic piping systems from 12 to 40 mm.
- Only 2.5 kg weight (without press jaw).
- Extremely small dimensions for mounting in confined pipe shafts and pre-wall installations.
- Service only after 30,000 pressings or 4 years.
- Safety lock after 32,000 pressings.

## Viega Megapress

# PIPE OVERVIEW.

Viega Megapress G: Steel pipes of boiler pipe quality (pipe series 1) and of threaded pipe quality according to the following two tables can be used with Megapress G.

Megapress G – boiler pipe quality – pipe series 1					
Thread size	Nominal width	Nominal external diameter	External diameter incl. coating	Pipe wall thickness DIN EN 10220/10216-1 seamless steel pipes	Pipe wall thickness DIN EN 10220/10217-1 longitudinal seam steel pipes
[Inch]	DN	[mm]	[mm]	[mm]	[mm]
½	15	21.3	20.8–21.8	2.0–3.2	2.0–3.2
¾	20	26.9	26.4–27.4	2.3–3.2	2.0–3.2
1	25	33.7	33.2–34.2	2.6–4.0	2.0–4.0
1¼	32	42.4	41.9–42.9	2.6–4.0	2.3–4.0
1½	40	48.3	47.8–48.8	2.6–4.0	2.3–4.0
2	50	60.3	59.7–60.9	2.9–4.5	2.3–4.5

Megapress G – threaded pipe quality					
Thread size	Nominal width	Nominal external diameter	External diameter incl. coating	Pipe wall thickness heavy series H in accordance with DIN EN 10255	Pipe wall thickness medium series M in accordance with DIN EN 10255
[Inch]	DN	[mm]	[mm]	[mm]	[mm]
½	15	21.3	21.0–21.8	3.2	2.6
¾	20	26.9	26.5–27.3	3.2	2.6
1	25	33.7	33.3–34.2	4.0	3.2
1¼	32	42.4	42.0–42.9	4.0	3.2
1½	40	48.3	47.9–48.8	4.0	3.2
2	50	60.3	59.7–60.8	4.5	3.6

Viega Megapress: The following steel pipes of boiler pipe quality and threaded pipe quality are suitable for Megapress connectors and press-in branch connectors (EPA). The different pipes include seamless (S) and longitudinal seam (W) pipes.

Megapress/Megapress S – DIN EN 10220/10216-1 and DIN EN 10220/10217-1 – boiler pipe quality – pipe series 1, 2 and 3					
Thread size	Nominal width	Nominal external diameter	External diameter incl. coating	Pipe wall thickness DIN EN 10220/10216-1 seamless steel pipes	Pipe wall thickness DIN EN 10220/10217-1 longitudinal seam steel pipes
[Inch]	DN	[mm]	[mm]	[mm]	[mm]
⅜	10	17.2	16.7–17.7	1.8–4.5	1.4–4.0
½	15	21.3	20.8–21.8	2.0–5.0	1.4–4.5
¾	20	26.9	26.4–27.4	2.0–8.0	1.4–5.0
1	25	33.7	33.2–34.2	2.3–8.8	1.4–8.0
–	32	38.0	37.5–38.5	2.6–10.0	1.4–8.8
1¼	32	42.4	41.9–42.9	2.6–10.0	1.4–8.8
–	40	44.5	44.0–45.0	2.6–12.5	1.4–8.8
1½	40	48.3	47.8–48.8	2.6–12.5 (2.3–4.0 EPA)	1.4–8.8 (2.3–4.0 EPA)
–	50	57.0	56.4–57.6	2.9–14.2	1.4–10.0
2	50	60.3	59.7–60.9	2.9–16.0 (2.3–4.5 EPA)	1.4–10.0 (2.3–4.5 EPA)
2½	65	76.1	75.3–76.9	2.9–20.0 (2.6–4.5 EPA)	1.4–10.0 (2.6–4.5 EPA)
3	80	88.9	88.0–89.8	3.2–25.0 (2.6–5.0 EPA)	1.4–10.0 (2.6–5.0 EPA)
4	100	114.3	113.2–115.4	3.6–32.0 (2.6–5.4 EPA)	1.4–11.0 (2.6–5.4 EPA)
5	125	139.7	138.3–141.1	2.9–5.4	2.9–5.4
6	150	168.3	166.6–170.0	2.9–5.4	2.9–5.4



**Megapress/Megapress S – DIN EN 10255 – threaded pipe quality – heavy series H and medium series M**

Thread size	Nominal width	Nominal external diameter	External diameter incl. coating	Pipe wall thickness for heavy series H	Pipe wall thickness for medium series M
[Inch]	DN	[mm]	[mm]	[mm]	[mm]
3/8	10	17.2	16.7–17.5	2.9	2.3
1/2	15	21.3	21.0–21.8	3.2	2.6
3/4	20	26.9	26.5–27.3	3.2	2.6
1	25	33.7	33.3–34.2	4.0	3.2
1 1/4	32	42.4	42.0–42.9	4.0	3.2
1 1/2	40	48.3	47.9–48.8	4.0	3.2
2	50	60.3	59.7–60.8	4.5	3.6
2 1/2	65	76.1	75.3–76.6	4.5	3.6
3	80	88.9	88.0–89.5	5.0	4.0
4	100	114.3	113.1–115.0	5.4	4.5
5	125	139.7	138.5–140.8	5.4	5.0
6	150	165.1	163.9–166.5	5.4	5.0

**Megapress/Megapress S – DIN EN 10255 – threaded pipe quality – pipe type L and pipe type L1**

Thread size	Nominal width	Nominal external diameter	External diameter incl. coating	Pipe wall thickness pipe type L	External diameter incl. coating	Pipe wall thickness pipe type L1
[inch]	DN	[mm]	pipe type L [mm]	[mm]	pipe type L1 [mm]	[mm]
3/8	10	17.2	16.7–17.4	2.0	16.7–17.4	2.0
1/2	15	21.3	21.0–21.7	2.3	21.0–21.7	2.3
3/4	20	26.9	26.4–27.1	2.3	26.4–27.1	2.3
1	25	33.7	33.2–34.0	2.9	33.2–34.0	2.9
1 1/4	32	42.4	41.9–42.7	2.9	41.9–42.7	2.9
1 1/2	40	48.3	47.8–48.6	2.9	47.8–48.6	2.9
2	50	60.3	59.6–60.7	3.2	59.6–60.7	3.2
2 1/2	65	76.1	75.2–76.0	3.2	75.2–76.3	3.2
3	80	88.9	87.9–88.7	3.2	87.9–89.4	3.6
4	100	114.3	113.0–113.9	3.6	113.0–114.9	4.0
5	125	139.7	138.5–140.8	4.5	–	–
6	150	165.1	163.9–166.5	4.5	–	–

**Megapress/Megapress S – DIN EN 10255 – threaded pipe quality – pipe type L2**

Thread size	Nominal width	Nominal external diameter	External diameter incl. coating	Pipe wall thickness
[inch]	DN	[mm]	[mm]	[mm]
3/8	10	17.2	16.7–17.1	1.8
1/2	15	21.3	21.0–21.4	2.0
3/4	20	26.9	26.4–26.9	2.3
1	25	33.7	33.2–33.8	2.6
1 1/4	32	42.4	41.9–42.5	2.6
1 1/2	40	48.3	47.8–48.4	2.9
2	50	60.3	59.6–60.2	2.9
2 1/2	65	76.1	75.2–76.0	3.2
3	80	88.9	87.9–88.7	3.2
4	100	114.3	113.0–113.9	3.6

**Key**

 Pipes for Megapress connectors

 Pipes for Megapress connectors and Megapress press-in branch connectors

 Pipes for Megapress press-in branch connectors

## Viega Megapress

# THE PRODUCT RANGE.

The product lines Viega Megapress and Megapress G are ideally tuned to the installation of thick-walled steel pipes. They offer a broad selection and high flexibility in installation with a large number of different connectors, such as e.g. sleeves, elbows, threaded adapters, reducers, T-pieces, and flanges. The Viega Megapress product line is available in the sizes  $\frac{3}{8}$ ,  $\frac{1}{2}$ ,  $\frac{3}{4}$ , 1,  $1\frac{1}{4}$ ,  $1\frac{1}{2}$ , 2,  $2\frac{1}{2}$ , 3, and 4 inches and is rounded off by adapters and reducing sleeves for steel pipes with external diameters 38.0, 44.5 and 57.0 mm. Viega Megapress G is available in sizes  $\frac{1}{2}$ ,  $\frac{3}{4}$ , 1,  $1\frac{1}{4}$ ,  $1\frac{1}{2}$ , and 2 inches.



- 4216
- 4316
- 4616



- 4216.1
- 4316.1
- 4616.1



- 4226
- 4326
- 4626



- 4226.1
- 4326.1
- 4626.1



- 4218
- 4318
- 4618



- 4215.1
- 4315.1
- 4615.1



- 4215.2



- 4217.2
- 4317.2
- 4617.2



- 4215
- 4315
- 4615



- 4215.4



- 4215.5
- 4315.5
- 4615.5



- 4215.7



- 4212
- 4312
- 4612



- 4211
- 4311
- 4611



- 4211.3



- 4213



- 4213.1



- 4265
- 4365



- 4263
- 4363
- 4661



- 4259
- 4259.1
- 4359
- 4359.1
- 4359.6
- 4659.5



INT 753 702-7/19-119116 · We reserve the right to effect changes.



**Viega Holding GmbH & Co. KG**

Viega Platz 1  
57439 Attendorn  
Germany

Phone +49 (0) 2722 61-0

[viega.com](http://viega.com)

